



LODGE HOT TUB COLLECTION

2019 PRICE LIST



THE BEST EXPERIENCE FOR YOUR GUESTS



Lodge L

While your guests experience Jacuzzi®, your business benefits from:

The power to boost profits.

A global brand association to increase bookings and occupancy.

Extended stays and repeat business.

High Season all year long no matter what the climate.

The ability to meet the demand for 'holidays with a hot tub'.

Better search engine hits through a known brand.

Increased value to your premises.

Enhanced selling points to your guests.

Excellent aftercare and a Customer Service team you can trust.

Advanced technology working at its best.

A specialist hot tub designed for the holiday and leisure industry.

The ideal hot tub for every kind of guest and booking.

A Hydromassage experience that only Jacuzzi® can deliver.



Lodge M

DISCOVER THE BEST



NORDIC INSULATION REDUCES RUNNING COSTS

Thanks to our Nordic heat and noise insulation system, Lodge keeps temperature loss to a minimum which means your running costs are reduced even in very cold conditions.

SEARCH ENGINES HAVE THE POWER

'Jacuzzi' is the keyword entered into search engines when customers are looking for a holiday with a difference. Choosing Jacuzzi® guarantees you an enhanced visibility within a crowded digital market and adds value to your property and services.

HALF THE TIME, TWICE THE ADVANTAGE

The Quick Drain device reduces drain times by up to 50% compared to standard drain pipes. All water is emptied out through a drain at the base of the tub which prevents stagnant water and allows a thorough clean before your next guests arrive. The complete drain is also aided by a flatter seat design on all models and an additional drain on the Lodge L lounge.

AUXILLIARY CONTROL PANEL

For ease of use and operator autonomy, this brand new feature integrates push buttons for guests with an advanced hidden control panel on all Lodge models.

DESIGNED FOR HOLIDAY RENTAL

From temperature lock controls to in-line chemical dispensers, the Lodge range includes several operating features designed specifically for the holiday rental market. There'll be less maintenance time with no head rests or diverter knobs to clean and replace, and peace of mind knowing that all in-filter dosing is HSE HSG282 compliant.

PERFECT TEMPERATURE, ALWAYS

As well as the standard heating systems, Lodge can be fitted with an electric heater or heat exchanger - an inexpensive green solution that exploits the heat produced by your facility's heating system or by renewable sources. The Additional Electric Heater Pack (2 x 3kw) reduces the time it takes to heat the water from cold, ensuring that your hot tubs are always at the perfect temperature for your guests even when you can't warm fill.

ULTRAVIOLET, ULTRA CLEAN

The ClearRay® system offers unbeatable benefits:

- Effectively treats 99.9% of waterborne pathogens;
- Reduce the use of chemical water treatment substances;
- Sanitises safely because it uses the electromagnetic energy produced by the sun to improve its disinfecting action;
- Easy to look after, the UV lamp must be replaced just once a year.

PERFORMANCE PACK

Available as an optional extra, the Performance Pack is a sand filter and filtration pump that sits remotely to the Lodge and provides enhanced filtration. This pack also helps to reduce maintenance time and cost due to eliminating the need to remove, clean, dry or replace paper filter cartridges on every change over day.

LODGE COLLECTION

Designed purely for the holiday market.

When frequency and flexibility are paramount for the use of hot tubs within your business, Lodge has all the answers.

Lodge

FEATURES	LODGE S	LODGE M	LODGE L
Dimensions	185 x 165 x 90cm	200 x 185 x 90cm	223 x 211 x 90cm
Seats	2-3 (1 lounge)	4-5	5-6 (1 lounge)
Jets	16	20	24
Light System	●	●	●
LED Control Panel	●	●	●
Insulating Cover	●	●	●
Cabinet Freestanding	●	●	●
Electric Heater	● 2KW	● 2KW	● 3KW
Amp	16 Amp*	16 Amp*	20 Amp*
Auxiliary Control Panel	●	●	●
Gate Valves	●	●	●
In-line Chemical Dispenser	●	●	●
ClearRAY® UV	●	●	●
Nordic Full Foam	●	●	●
OPTIONS			
Heat Exchanger	<input type="radio"/> (8.8 Amp)	<input type="radio"/> (8.8 Amp)	<input type="radio"/> (8.8 Amp)
Additional Electric Heater Pack (2X3kw)	<input type="radio"/>	<input type="radio"/>	<input type="radio"/>
Performance Kit	<input type="radio"/>	<input type="radio"/>	<input type="radio"/>
Covermate 1 - Cover Lifter	<input type="radio"/>	<input type="radio"/>	<input type="radio"/>
Cover Mate 2 - (with undermounted brackets) Cover Lifter	<input type="radio"/>	<input type="radio"/>	<input type="radio"/>

● Included ○ Optional
* Running high speed pump or heater

Performance Pack

70cm x 40cm x 64cm

£719^{inc VAT}
£599^{ex VAT}

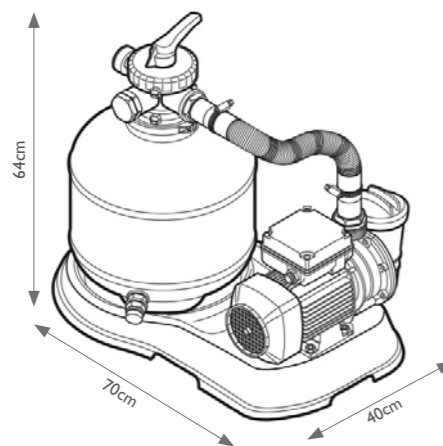

Additional Heater Kit

2 x 3kw

£359^{inc VAT}
£299^{ex VAT}



Lodge S
185 x 165 x 90 cm
Seating Capacity: 2-3 (1 lounge)
Total Jets: 16

2 kw heater
ClearRAY®
Nordic Insulation

£5,249^{inc VAT}
£4,374^{ex VAT}

Special Order
+ Heat exchanger

£5,649^{inc VAT}
£4,708^{ex VAT}

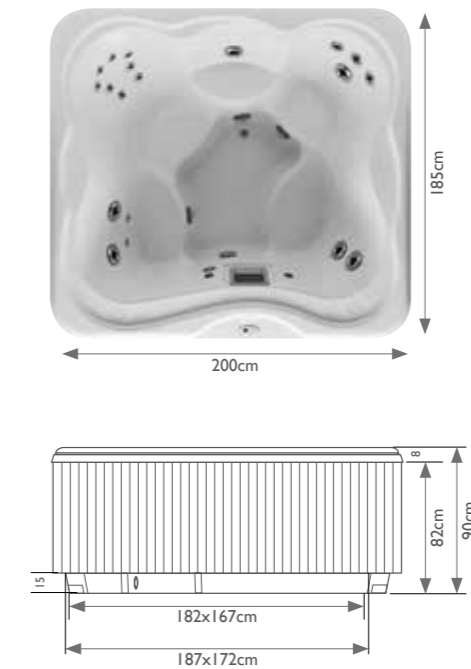

Lodge M
200 x 185 x 90 cm
Seating Capacity: 4-5
Total Jets: 20

2 kw heater
ClearRAY®
Nordic Insulation

£5,749^{inc VAT}
£4,791^{ex VAT}

Special Order
+ Heat exchanger

£6,149^{inc VAT}
£5,124^{ex VAT}

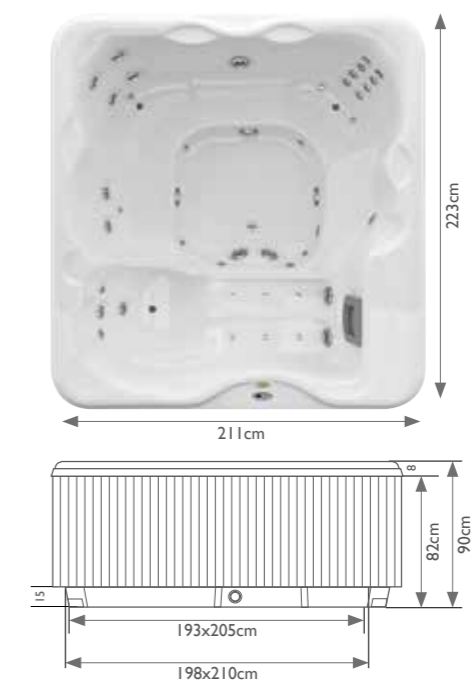

Lodge L
223 x 211 x 90 cm
Seating Capacity: 5-6 (1 lounge)
Total Jets: 24

3 kw heater
ClearRAY®
Nordic Insulation

£7,499^{inc VAT}
£6,249^{ex VAT}

Special Order
+ Heat exchanger

£7,899^{inc VAT}
£6,583^{ex VAT}

CELEBRATING
OVER

60

YEARS

OF HYDROTHERAPY

 www.jacuzzi.co.uk

 0113 272 7430

 commercialsupport@jacuzzi.co.uk

 Jacuzzi Spa and Bath Limited,
Old Mill Lane, Low Road,
Hunslet, Leeds LS10 1RB